

A STUDY ON PARAMETRIZATION AND IMPLEMENTATION OF SUBWOOFER ARRAYS FOR ACTIVE NOISE CONTROL IN EVENT NOISE MANAGEMENT

C Frick Rocket Science GmbH, Zürich, Switzerland, christian.frick@rocket-science.ch
P Nüesch Rocket Science GmbH, Zürich, Switzerland, patrick.nueesch@rocket-science.ch

1 INTRODUCTION

Event noise management at outdoor festivals faces the problem of providing an excellent sound experience for the audience and complying with the local regulations on sound exposure of neighboring residential areas. If these regulations enforce too low sound pressure levels in the listening area, the sound experience will suffer. Otherwise, it's obvious that too high sound pressure levels in the neighborhood will have a negative impact on the quality of residents' life, which makes regulation and compliance important. Dense building development also aggravates this problem. Based on our experience, most of the residents' complaints will be due to low frequency emissions in the range below 100 Hz. Low frequencies are less attenuated by air and are damped the least by structures. At the same time, it is worth mentioning that modern productions tend to have a high bass content.

Therefore, the noise protection problem at outdoor concerts focuses on frequencies lower than 100 Hz. This problem is tackled by using well known techniques like cardioid and end fire sub-woofer arrays, beam forming using signal delays and amplitude tapering to focus the sound energy as homogeneous as possible in the main lobe on the axis orthogonal to the stage. To control the offsite emission of low frequencies, we place an active noise control (ANC) subwoofer array behind the audience. This ANC array is designed in a way to generate the same dispersion pattern as the main array on stage. In order to cope with changing environmental conditions like temperature and wind, we use adaptive state of the art ANC algorithms running on proprietary hardware. The functionality of the system described in this paper has been proven several times under real life concert conditions.

It is however important to state that no matter how good and protective a system design is in reverse direction and off-axis (in the direction of the elements of the array, orthogonal to the direction from the stage to the audience), the problem on-axis persists, since the main lobe energy is required for the sound experience of the audience. Therefore, an ANC solution must be able to eliminate main lobe energy behind the audience to provide a good on-axis off-site soundproofing.

2 CONCEPT

A successful implementation of active noise control in event noise management requires a holistic approach. To achieve good ANC performance, the spatial sound pressure distribution generated by the main array and the transfer function from the main input to the location of the ANC array should fulfill some important design guidelines. These guidelines and ways to realize them will be explained in detail in the third section (Methods). Other aspects, like the preservation of sufficient headroom are of equal importance. An ANC concept for low frequency event noise management can therefore be divided into the following main points.

2.1 DESIGN OF MAIN ARRAY

The subwoofer array of the sound reinforcement system must be designed and parametrized in a way, that it is noise protective in rearward direction and off-axis (in lateral directions). The sound pressure distribution on-axis (in front of) the main array should be spatially as homogeneous as

possible over the whole frequency range of interest. This leads to an even frequency response, which is almost constant over the whole coverage pattern.

2.2 DESIGN OF ANC ARRAY

For an effective cancellation of sound, the coverage pattern of the ANC array must reproduce the coverage pattern of the main array as accurately as possible over all frequencies of interest. This can be achieved by the usage of the Huygens-Fresnel principle.

2.3 USE OF FILTERED-X LMS ALGORITHM

Adaption to changing environmental conditions requires the use of adaptive filters for primary and secondary path identification. These are implemented by LMS algorithms on a single-in-single-out (SISO) DSP device.

2.4 OTHER ASPECTS

It's essential to keep enough headroom for the ANC to work properly introduced nonlinearities would significantly decrease the system performance. Other aspects to be considered are the audibility of the ANC array in the audience and the selection of the error microphone location.

3 METHODS

3.1 DESIGN OF MAIN ARRAY

3.1.1 BACKWARD PROTECTION BY USE OF CARDIOD SUBWOOFER ARRAYS

The use of cardioid subwoofer arrays is quite common today. By using cardioid systems, the front-to-back SPL ratio will typically¹ reach about 20 dB. This is a simple measure in terms of cost and complexity and can always be applied. The following picture shows a comparison of the coverage pattern of ideal omni and cardioid subarrays at a simulation frequency of 63 Hz.

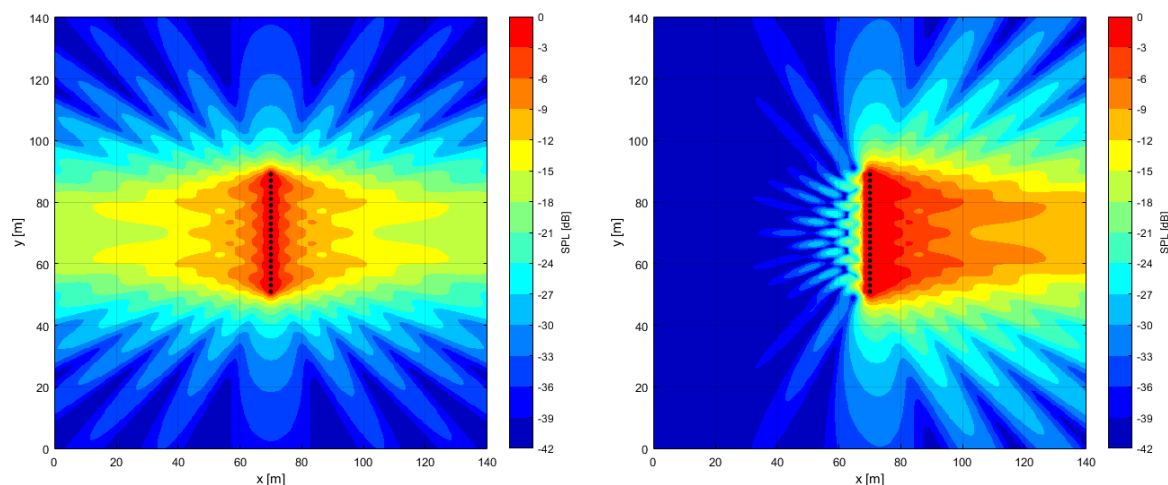

Figure 1: Two simulations showing relative SPL coverage patterns of line arrays with 20 subs each, left side: omnidirectional point sources, right side: cardioid dipoles (implemented by pairs of two omnidirectional point sources). The lateral spacing between the elements is 2m.

3.1.2 LATERAL (OFF-AXIS) PROTECTION: ELEMENT SPACING DISTANCE

Lateral (off-axis) protection: Element spacing distance

To be protective off-axis, the element spacing between individual subwoofers should be small in comparison to the wavelength of the highest considered frequency. Literature indicates that the spacing shouldn't exceed 2/3rd of the wavelength². At a given array length, smaller spacing increases the number of subs, which can be an economical issue. Simulation results indicate that even at a spacing of 3/4th of the wavelength, the generated side lobes (in the line of the array) are still acceptable.

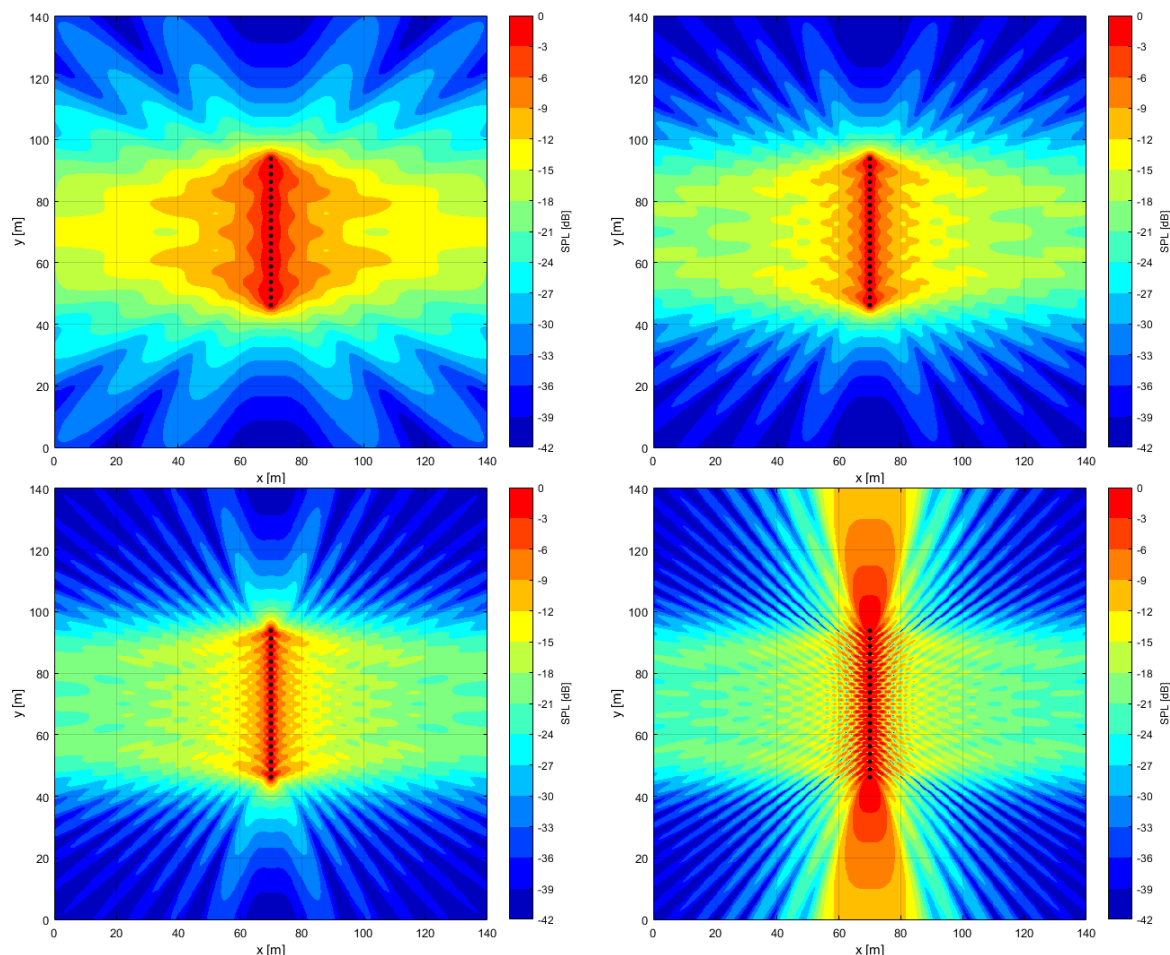

Figure 2: Simulation results for an element spacing of 2.5m. From left to right and top to bottom the images show SPL coverage patterns for following frequencies: 34 Hz ($\lambda = 1/4$ spacing), 69 Hz ($\lambda = 2/4$ spacing), 103 Hz ($\lambda = 3/4$ spacing) and 137 Hz ($\lambda = 4/4$ spacing).

3.1.3 TAILORING THE MAIN LOBE BY USING A VIRTUAL POINT SOURCE

The shape, in particular the width and direction, of main lobe facing towards the audience can be controlled by delaying the signals to the subs of the array. These delays are chosen in a way to emulate the field of a virtual point source behind the main array at some distance from the

audience. By increasing the distance, the opening angle gets smaller, whereas by lowering the distance, the angle becomes wider. Using this virtual point source, areas on the left and right side (viewed from stage) of the audience can be protected and the coverage pattern can be adjusted to the desired geometry. The delays of the individual speakers are simply calculated by the travel time of sound from the virtual point source to each speaker. The travelling time to the closest speaker can then be subtracted from each individual delay without affecting the resulting coverage pattern. The following plots show simulation results for a wide and a narrow opening angle.

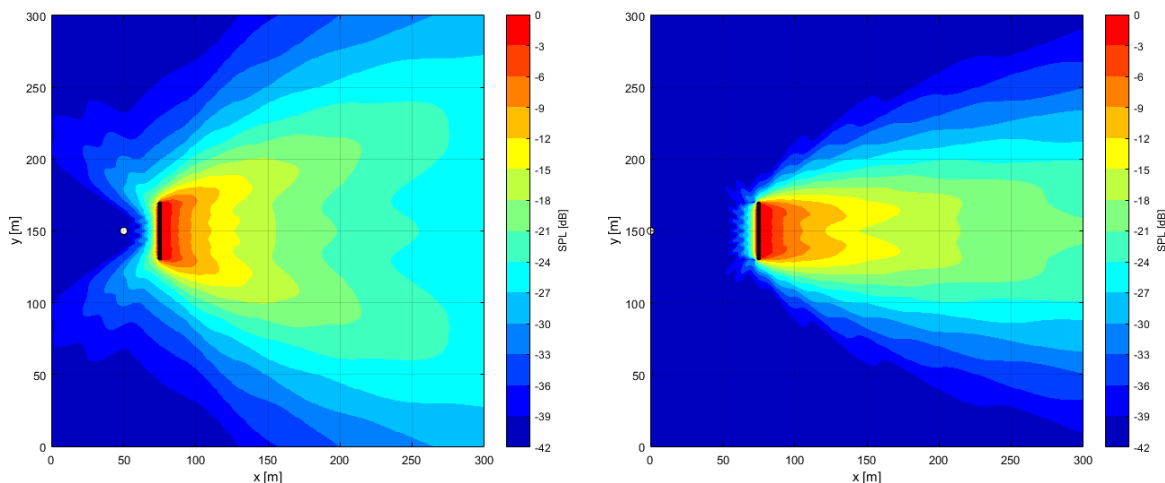

Figure 3: Simulations of SPL coverage patterns for array delays corresponding to a virtual point source (shown as white point). The left image shows a wide opening angle which results from a virtual point source at a distance of 25 m to the array. The image to the right depicts a narrower opening angle due to a longer distance of 75 m. The frequency used in this simulation is 63 Hz, the spacing between the speakers is 2 m and a tukey tapering function was utilized (this will be explained further down).

3.1.4 ON-AXIS PROTECTION: USE OF ANC METHODS MANDATORY

The only possible way to lower the SPL levels at bass frequencies behind the audience is the use of active noise cancellation methods. Passive methods like absorbers would be mostly inefficient for low frequencies. An active approach will be discussed in detail in subsections 3.2 and 3.3.

3.1.5 HOMOGENEOUS PRESSURE DISTRIBUTION: USE OF A WINDOW FUNCTION

On-site it is desirable to achieve a SPL distribution which is as homogeneous as possible over the whole frequency range up to 100 Hz. This is due to two reasons. Firstly, strong lobing patterns decrease the perceived sound quality. Secondly, if the sound pressure is constant in space, the exact positioning of the error microphone doesn't have a big impact on the measured transfer function. Otherwise, in a sound field with strong lobing patterns, the transfer functions to different points in space will strongly differ from each other, which complicate the application of ANC methods.

Most windowing functions used for array parametrization produce small amplitude weighting taps for lateral elements in the phased array. For economic reasons a minimal amplitude taper is defined to prevent the placement of loudspeakers that contribute an irrelevant sound energy to an overall sound field. This as a compromise between physical requirements and the production budget.

The following plots show results of simulations of (qualitative) optimal and suboptimal but economically bearable tapering functions. Power losses of about 2-3 dB in favor of field homogeneity are considered as acceptable. The tukey window function³ (tapered cosine window)

delivers good results. Overall, the use of a suited tapering window functions requires a bit of additional headroom but produces a narrower coverage angle.

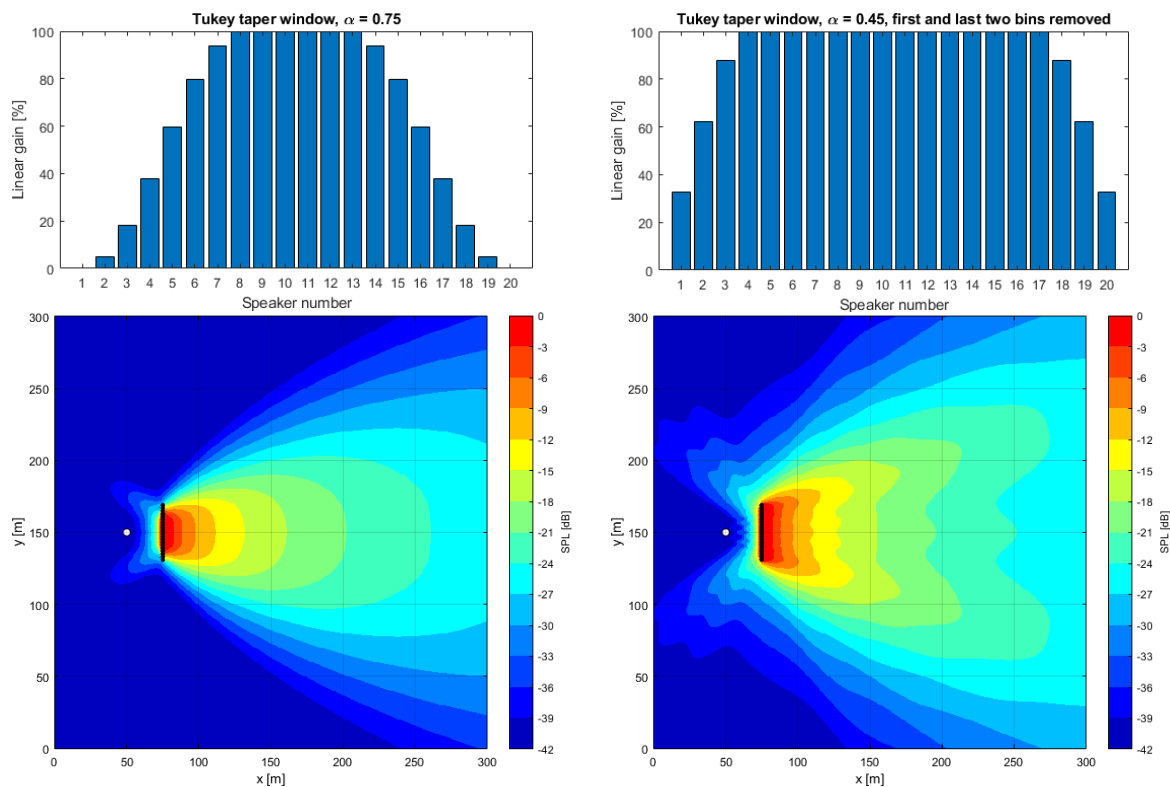

Figure 4: Simulation results using a tukey window tapering function. The simulation shows a cardioid sub array of 20 speakers with 2 m spacing at 63 Hz. The virtual point source is placed 25 m behind the array. On the left side the linear gains of a tukey window function with parameter³ $\alpha = 0.75$ are shown. This produces a very homogenous field in front of the array. On the downside these settings result in an overall loss of -4.5 dB, which is not considered to be economical. The images on the right side show a more economical setting, using a tukey window with parameter $\alpha = 0.45$. The window shown here was calculated for 24 instead of 20 speakers, but the 4 speakers with lowest amplitudes were simply neglected. This leads to an overall loss of only -1.1 dB, while still delivering acceptable results.

3.2 DESIGN OF ANC ARRAY

The design of the ANC array behind the audience follows the same procedure and principles as the design of the main array. Due to sound quality considerations, cardioid systems should be used to suppress interference effects with the sound pressure field on-site. To reduce spatial lobing patterns and reproduce the homogeneous field of the main array, the use of a tapering function for the ANC array is highly recommended. In order to replicate the general shape of the pressure field generated by the main array, we use the same virtual point source technique that was used for the main array. This means, for each individual speaker a delay corresponding to the travel time of sound from the virtual point source to each speaker of the ANC array is applied. The travel time to the closest speaker of the main array, if it was subtracted according to the description in subsection 3.1, must be subtracted here too. This procedure produces the same coverage pattern as the main array. Additionally, occurring frequency dependent phase factors and correct adaption of the overall amplitude will be handled by the algorithm described next.

3.3 USE OF FILTERED-X LMS ALGORITHM

3.3.1 PRIMARY PATH IDENTIFICATION

In contrast to other ANC applications (like noise cancelling headphones), this application includes transfer functions over large distances. The transfer function from the main array to the quiet zone can easily span 150 m to 200 m and is therefore highly influenced by atmospheric conditions like temperature and wind. This primary path is identified and adapted online to react to changing environmental conditions (like temperature drops during a concert). This online adaption is performed by a least mean squares algorithm⁴.

3.3.2 SECONDARY PATH IDENTIFICATION

The transfer function from the ANC array to the error microphone (the secondary path) is identified by a preconditioned leaky filtered-x LMS algorithm⁵. This is done in a static fashion by injecting bandwidth limited noise into the ANC array. The weights of the x-filter are then determined by the LMS algorithm. This is normally done once before an event, but it's also possible to run this secondary path identification during the operation of the system.

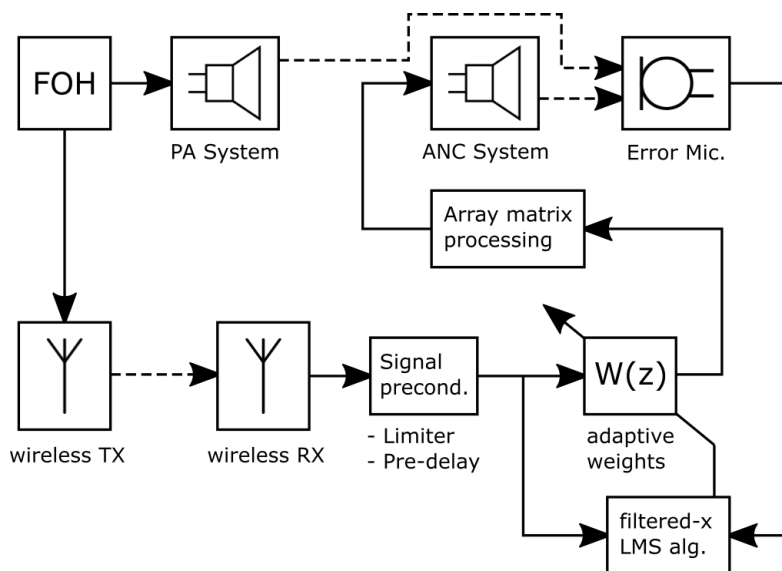

Figure 5: Simplified diagram of the SISO (Single-In-Single-Out) filtered-x LMS algorithm and its implementation in the sound reinforcement system.

3.4 OTHER ASPECTS

3.4.1 NONLINEARITIES AND HEADROOM OF THE TWO ARRAYS

Nonlinearities, due to lack of headroom, cause harmonic distortion and severe changes in the coverage pattern of the main array. Missing headroom on the main system will cause the onset of limiting for individual loudspeakers in the array and distorts the amplitude taper used for coverage control and the reduction of spatial aliasing effects. For cardioid sub arrays this effect is referred to as pattern implosion⁶. As an effect the coverage patterns of the main array and the ANC array will differ and the geometry of the zone of silence will suffer.

Harmonic distortion is the result of exceeding the linear range of operation of the loudspeakers and generates harmonic frequency components which are not present in the original signal and therefore cannot be controlled by a simple feed forward controller. Distortion on the ANC system

has to be avoided in all cases since the human perception is more sensitive to harmonic frequency components that are generated by distortion than to the problematic fundamentals that need to be controlled. With missing headroom in the ANC array and the onset of limiting in the ANC array the LMS algorithm will start to work against the limiters of the system and therefore becomes unstable.

3.4.2 AUDIBILITY OF THE ANC SYSTEM IN THE AUDIENCE AREA

The ANC system must not affect the sound quality in the audience area. By building the ANC array of cardioid elements which show a high front-to-back SPL ratio an ANC system can be realized that radiates most energy in direction of the propagation of the primary sound wave with a negligible spill of energy towards the audience. In special cases, omnidirectional elements can be used to set up the ANC array, which then acts as a reflector and can deliver sound energy back to the audience.

3.4.3 SELECTION OF ERROR MICROPHONE POSITION AND SIZE OF SILENT ZONE

The main array and the ANC array are separated by a spatial distance which is given by the event. For any measurement point in the far field the geometrical dilution of sound energy radiated by two separate and distant (point) sources is equivalent with having two inverse square laws. The highest reduction in SPL is achieved at the error microphone, where the two sound waves are adjusted to have the same amplitude but opposite phases. The reduction of sound pressure level persists into the far field, but cancellation efficiency is a function of the distances between the two arrays and the silent zone.

Due to the high spatial homogeneity in the frequency spectrum over the whole main lobe, the performance of the ANC method is not strongly influenced by the exact location of the error measurement microphone inside the silent zone.

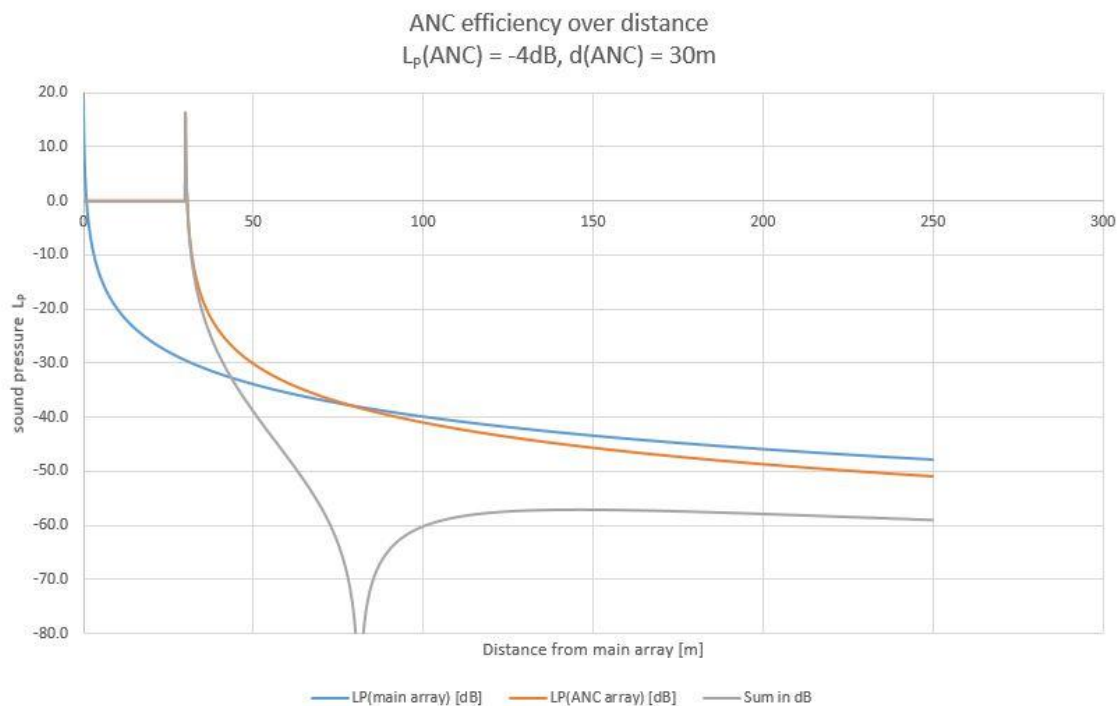

Figure 5: Simulation of the ANC efficiency over large distances. The sound pressures of the main array, the ANC array and their resulting sum are plotted against distance. The ANC is placed in a distance of 30 m from the main array with a sound pressure level 4 dB lower compared to the main array.

4 RESULTS

4.1 SIMULATION RESULT

The following contour plots show simulation results of sound pressure levels at an outdoor concert event. The main array, consisting of 14 speakers, was designed according to the principles described above, and an ANC system of 20 speakers was placed at a distance about 65 m from the main array. Sound pressure levels behind the main stage and lateral to the audience dropped rapidly. Behind the audience, a homogeneous level distribution was achieved. Using the ANC system, the SPL behind the audience could be reduced significantly without relevant overshoot towards the border of the silenced zone and without considerably influencing the field distribution in the listening area. The simulation results suggest that the pressure level behind the audience (at the position of measurement microphones) can be lowered by 15-18 dB.

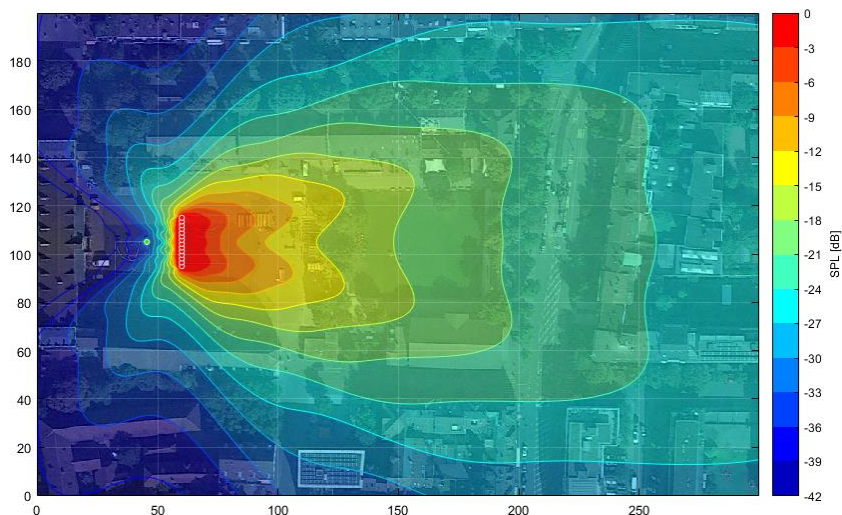

Figure 6: Simulation results of the sound pressure level produced by the main array (red dots) at a live concert. The virtual point source is shown as a green dot. The array is parametrized in a way to produce a homogeneous sound pressure distribution.

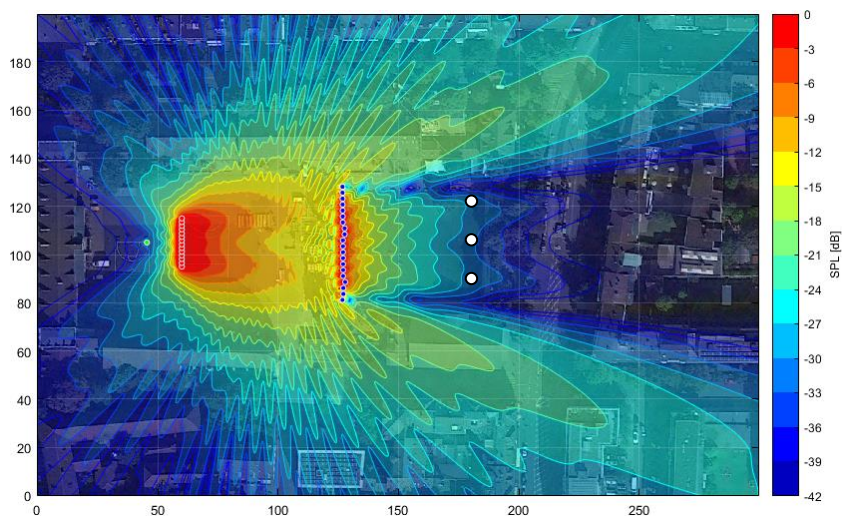

Figure 7: Simulation results of the same situation as in figure 6, but now with the ANC system (blue dots) turned on. The SPL can be reduced by 15-18 dB in propagation direction behind the ANC array. There is no significant buildup of lateral sound energy emissions. Three different measurement positions are shown as white circles.

4.2 MEASUREMENTS UNDER REAL LIFE CONCERT CONDITIONS

During a concert with contemporary pop music, the real time spectral composition of the immission at three different measurement positions (see figure 7) in 140 m distance to the stage show a very pronounced 30 dB peak in the low frequency range around 50 Hz.

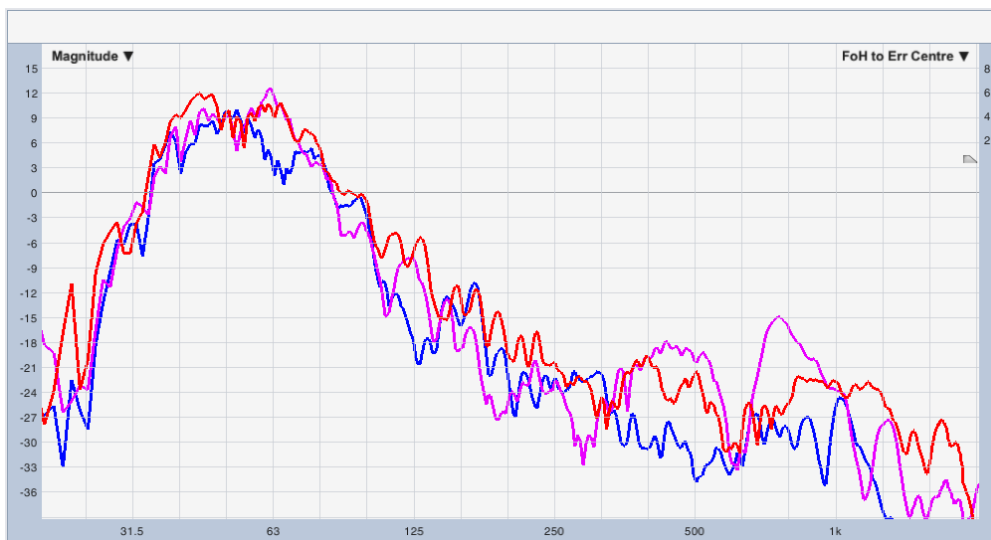

Figure 8: Smart RTA measurements at the point of immission. The transfer function of three error microphone positions (shown in figure 7) are plotted. The data is smoothed over 1/12 octave.

By turning on the ANC array, the predominant peak around 50 Hz can be reduced by approximately 18 dB (SPL) at the position of the central error microphone and by approximately 12 dB (SPL) at the two lateral microphone positions. The active control method is effective over the whole sector behind the ANC array, without relevant overshoot towards the border of the silenced zone.

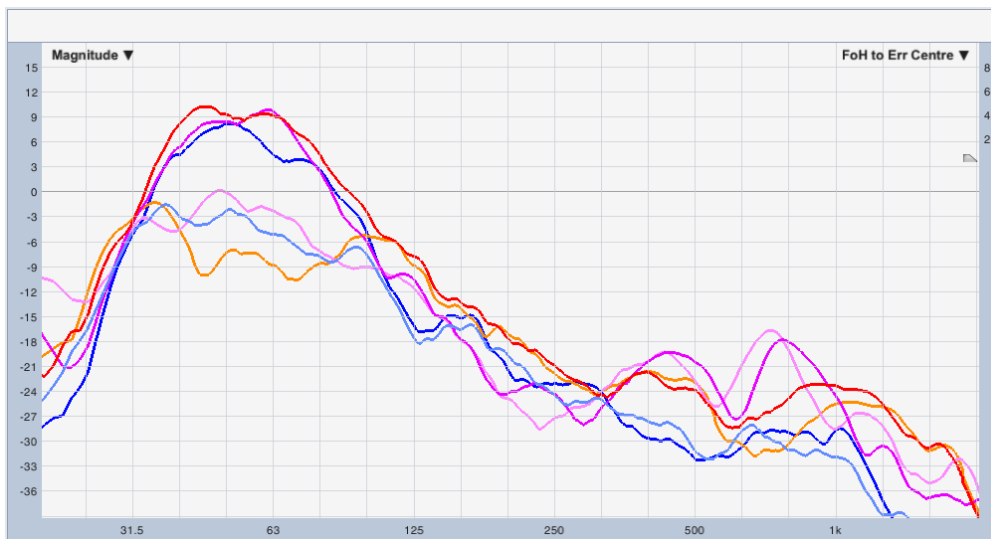

Figure 9: Efficiency of the LMS-based ANC algorithm. The bright lines show measurements while the ANC system is turned on, compared to the dark lines where the ANC System is turned off. A SPL reduction up to 18 dB is achieved around 50 Hz. The data is smoothed over 1/3 oct. The red (ANC off) and the orange (ANC on) curves belong to the central measurement position in figure 7. The other four curves belong to the lateral microphone positions.

5 DISCUSSION

By careful design and simulation of sound reinforcement system dispersion, the polar diagram of the main array and the ANC array coincide and show an even and homogeneous frequency response. This is a requirement for a good ANC performance over the whole sector which is spanned by the ANC array. In this case, the exact microphone position is not critical anymore. In such a setup, good ANC performance can be achieved using a single-channel filtered-x LMS algorithm.

Under real life conditions, it could be shown that such a system can reduce the sound pressure level of low frequencies (around 50 Hz) behind the concert area by up to 18 dB. This leads to a significant reduction of noise in adjacent areas. The system described here represents an effective and economical solution for the problem of event noise management.

6 REFERENCES

1. McCarthy, B., "Sound Systems: Design And Optimization", third edition, pp. 319, 2016
2. McCarthy, B., "Sound Systems: Design And Optimization", third edition, pp. 282, 2016
3. Harris, F. J., "On the use of Windows for Harmonic Analysis with the Discrete Fourier Transform", Proceedings of the IEEE. 66(1), pp. 51–83, 1978
4. Hansen C., "Active Control of Noise and Vibration", second edition, vol. 1, pp. 409, 2013
5. Hansen C., "Active Control of Noise and Vibration", second edition, vol. 1, pp. 492 and pp. 574, 2013
6. McCarthy, B., "Sound Systems: Design And Optimization", second edition, pp. 314, 2010